

***NATIONAL
ICE HOCKEY OFFICIALS
ASSOCIATION***



**2012
OFFICIATING MECHANICS
2 Referees**

Face-off - Dropping the Puck

The official dropping the puck shall set the players and hold the puck at the beltline. When the players are legally set, the official shall drop the puck. The official will not present the puck or hold the puck away from the beltline.

Face-off

Start of Game, Periods, Overtime, After Goal

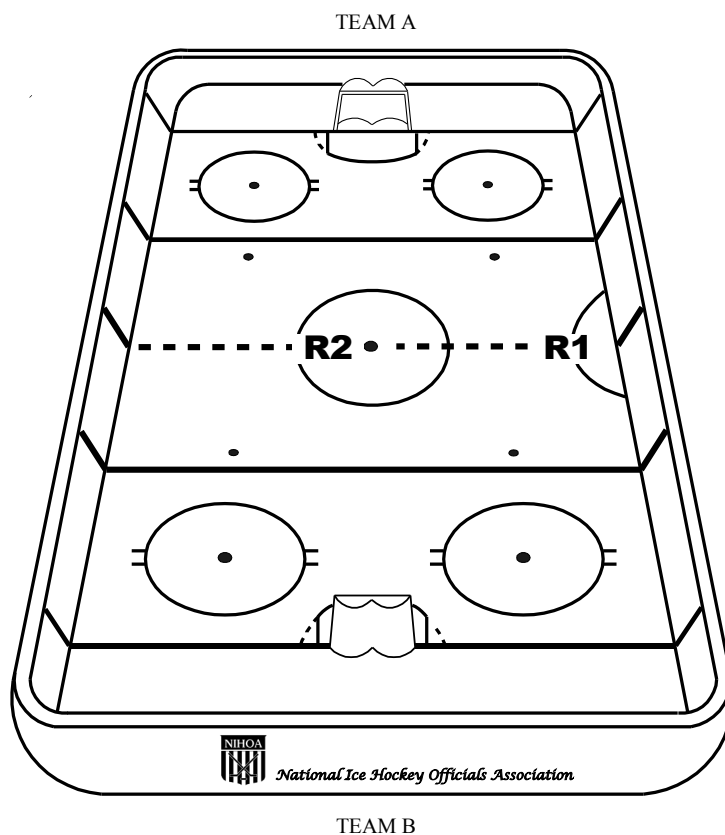

R2 always will face the timekeeper/penalty box when ropping the puck at the start of the game, periods, overtime and after a goal.

**Note: Rs are numbered for identification only.*

Face-off Goal Scored

TEAM A

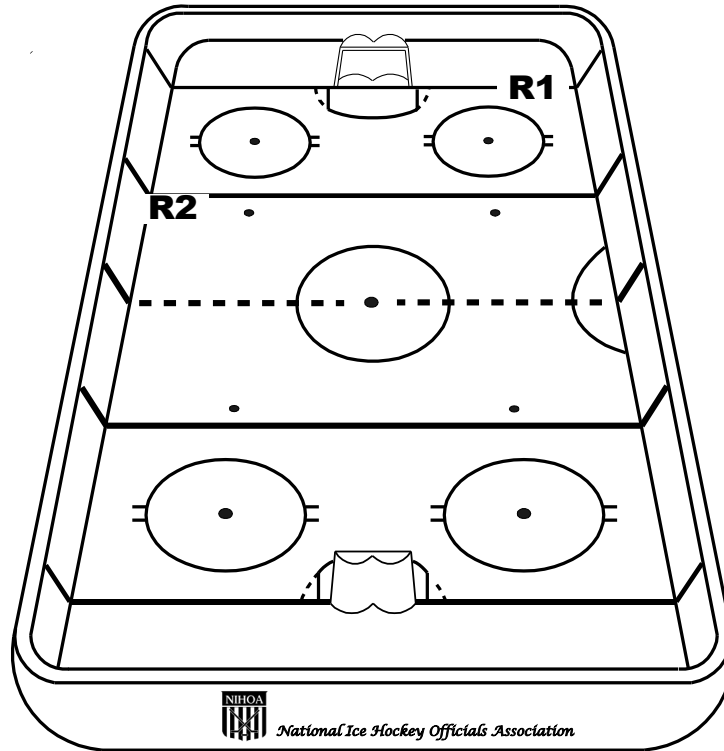

TEAM B

R2 on blue line will retrieve the puck and will observe players while moving to center spot.

R1 will report the goal.

R2, after conducting the line change procedure, will conduct face-off.

Note: Both officials, while conducting their duties, will continue to be observant of players. There is no reason to rush in picking up the puck or to report the goal.

****Note: Rs are numbered for identification only.***

After Center Ice Face-off

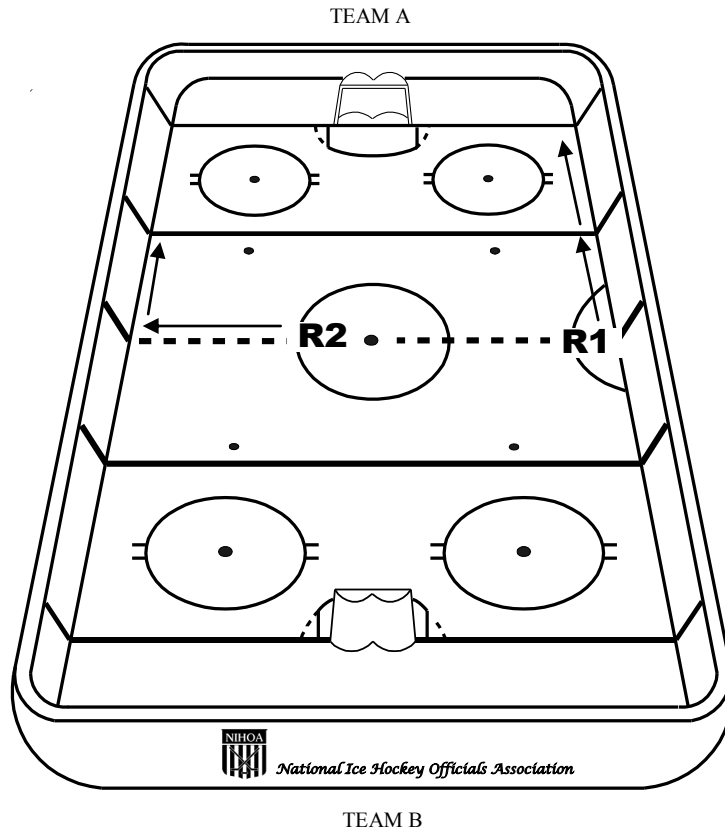

- R2 drops puck facing the timekeeper/penalty box.**
- R1 observe players and benches**
- R1 will go with the play.**
- R2 will back out of the center spot and assume position depending on which way R1 goes.**
- If the puck proceeds into Team A's zone, R1 will cover the Team A blue line. If the play continues into Team A's zone R1 will continue into the zone with the play. R2 will take a position just outside of the blue line.**

**Note: Rs are numbered for identification only.*

Zone Line Face-off

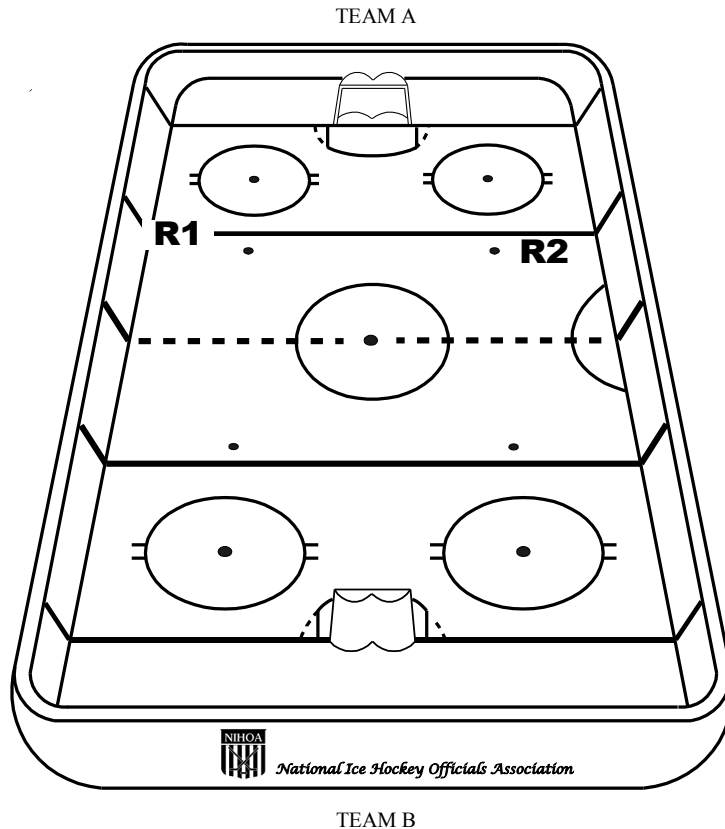

R2 will drop the puck facing the far side of the ice.

R1, after conducting the line change procedure, will take the proper position for the face-off, and will cover the blue line.

**Note: Rs are numbered for identification only.*

After Neutral Zone Face-off

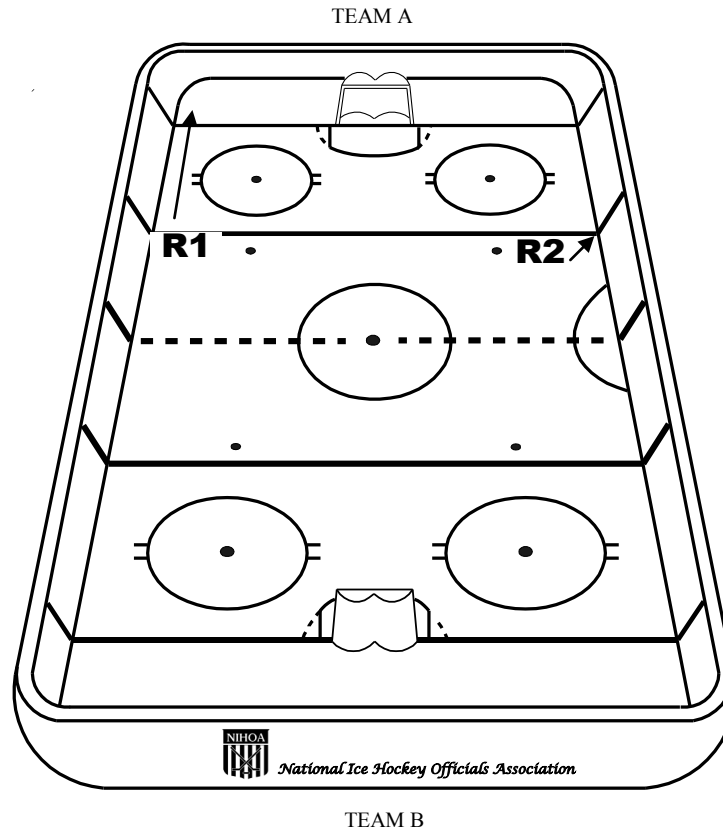

If the puck advances towards Team A's zone, R1 will cover the Team A blue line. If the play continues into Team A's zone R1 will continue into the zone with the play. R2 will take a position just outside of the blue line.

**Note: Rs are numbered for identification only.*

After Neutral Zone Face-off

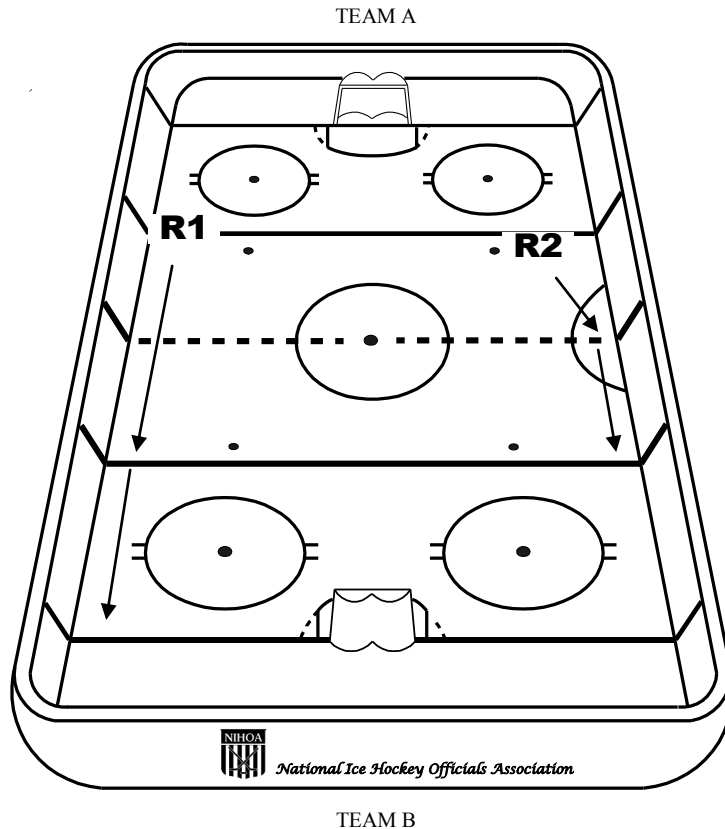

If the puck proceeds into Team B's zone, R1 will cover the Team B blue line. If the play continues into Team B's zone R1 will continue into the zone with the play. R2 will take a position just outside of the blue line.

**Note: Rs are numbered for identification only.*

Offside

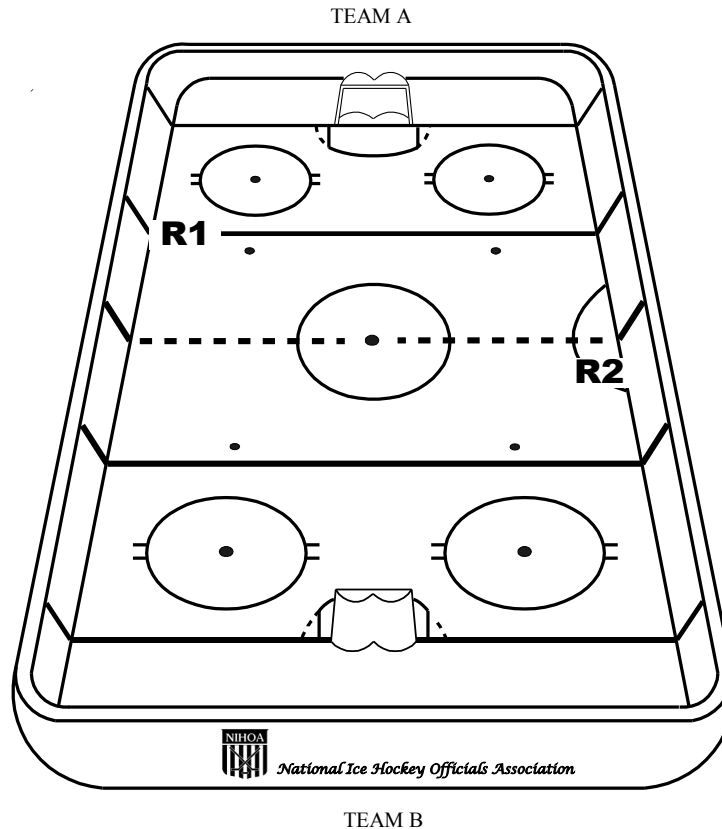

R1 has called an off-side. R1 will go to the location of the face-off. R2 will pick up the puck and bring it to R1.

On a delayed offside, the official signaling the delay raises the non-whistle arm and brings the other hand out and points with the open palm.

**Note: Rs are numbered for identification only.*

End Zone Face-off

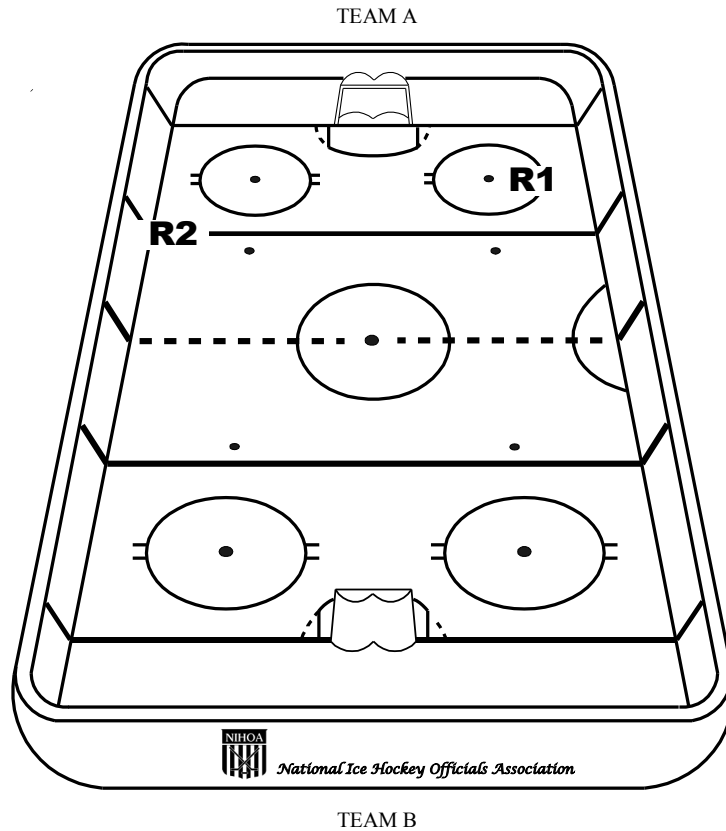

R1 will conduct the proper face-off.

R2, after conducting the line change procedure, will take the proper position for the face-off.

**Note: Rs are numbered for identification only.*

After End Zone Face-off

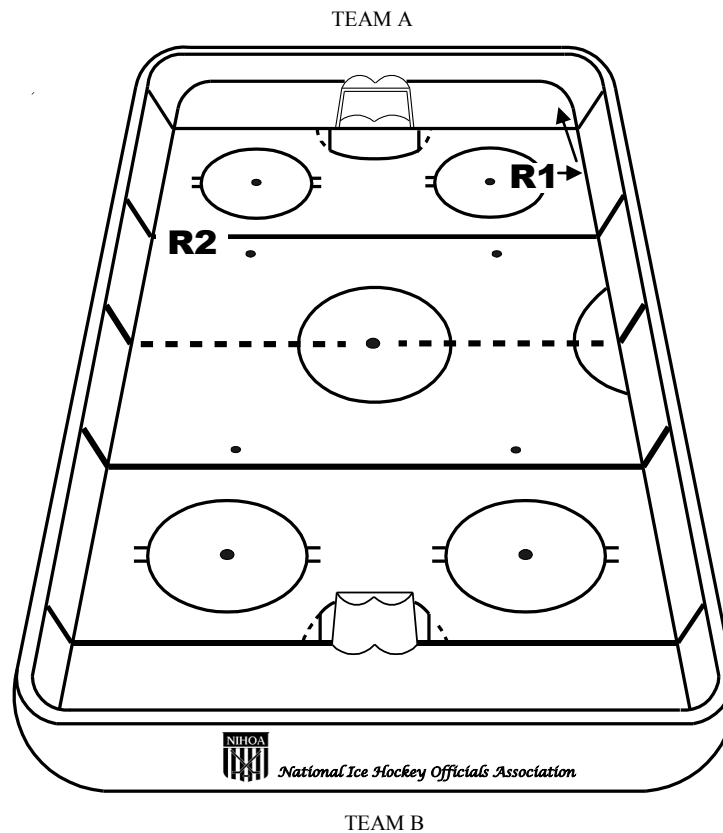

R1, after dropping the puck, will move back to the boards and out of play.

R2, positioned just outside the Team A blue line, will hold the position.

**Note: Rs are numbered for identification only.*

After End Zone Face-off

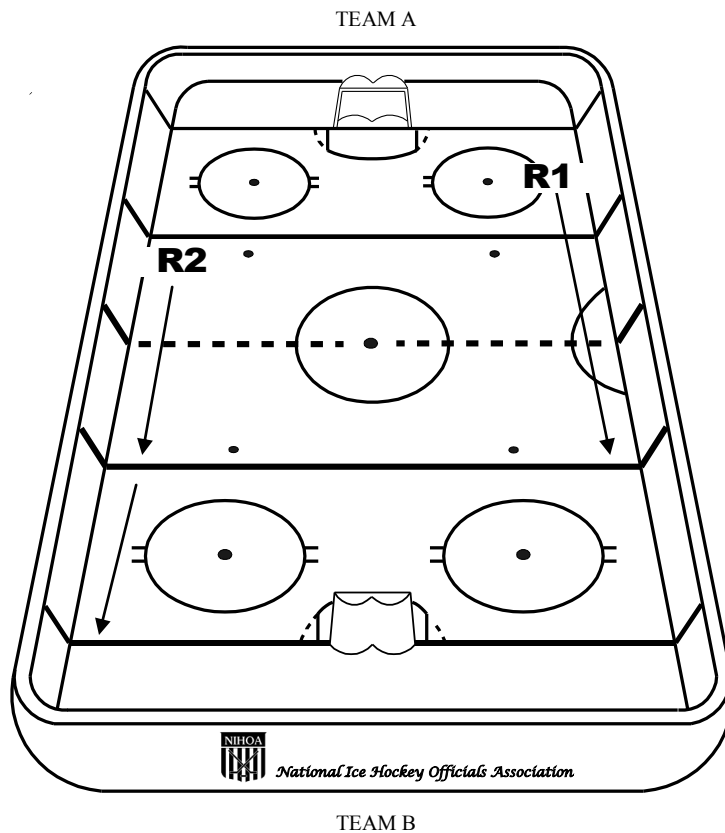

On the face-off, if the puck immediately proceeds to the Team B's zone, R2 will cover the Team A blue line. If the play continues to move up the ice, R2 will move up to cover the far blue line. R2's primary responsibility will be to get to the far blue line to call an offside.

After dropping the puck, R1 will be the trailing official and will move up just outside of the Team B blue line.

**Note: Rs are numbered for identification only.*

Face-off between Blue Line and Top of End Zone Face-off Circle

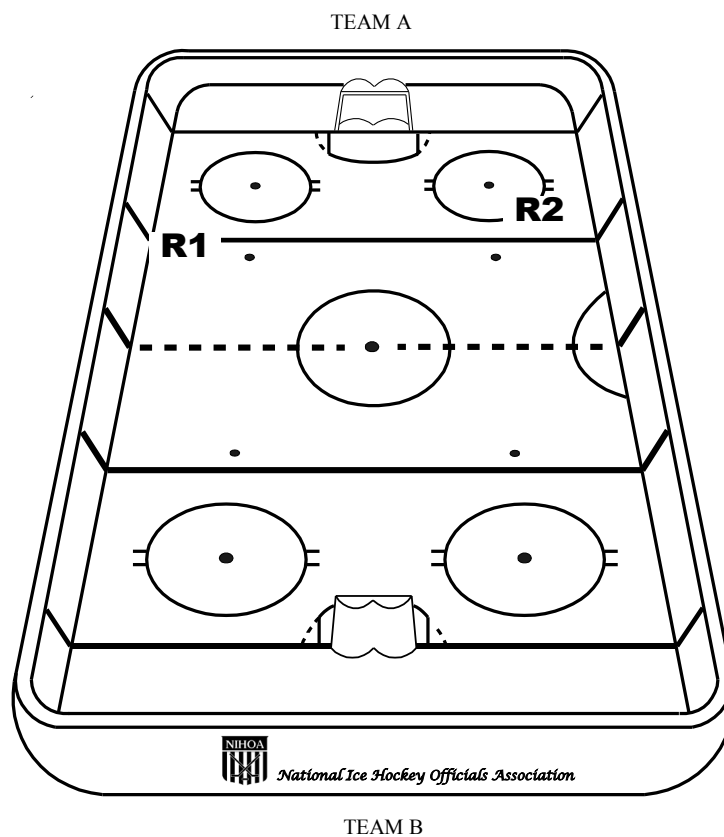

When a face-off takes place in the Team A zone (between the top of the special spot face-off circle and the blue line), R2 will conduct the face-off. R1 should line up just outside of the blue line on the opposite side of the ice.

**Note: Rs are numbered for identification only.*

Penalty Shot

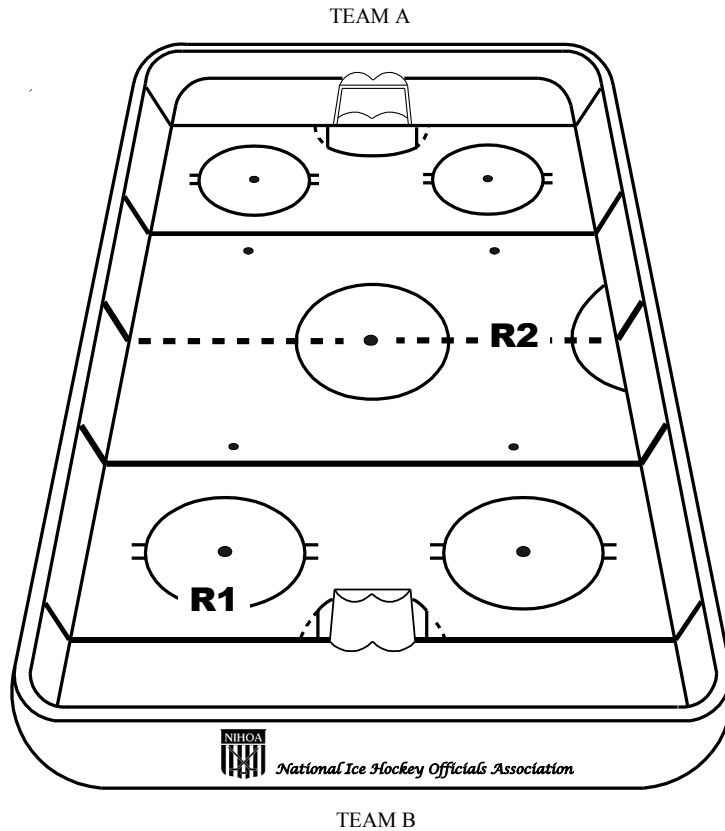

**R1 is on the goal line and signals a legal goal, if scored.
R2 is positioned at the red line conducting the penalty shot procedure.**

**Note: Rs are numbered for identification only.*

Icing

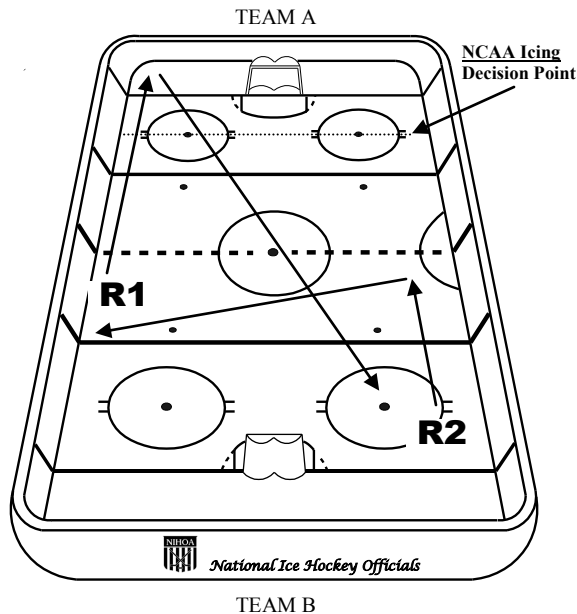

R2 signals icing by raising the non-whistle arm at a 70-degree angle towards Team A's zone and skates with the arm raised into the center ice zone.

R1 on receiving the icing signal skates towards Team A's goal line extended.

If the puck crosses Team A's goal line extended before it is played or can be played by Team A, R1, after checking with R2 to see if icing is still on, immediately raises the non-whistle arm and blows the whistle stopping play.

R1 retrieves the puck, hustles to face-off location and prepares to drop puck. R2, after pointing to the location of the face-off, starts 15 second line change procedure. At conclusion of line change procedure R2 takes proper position for face-off.

If the puck can be played by Team A or is played by either team before it crosses Team A's goal line extended, R1 will give the washout signal nullifying icing.

**Note: Rs are numbered for identification only.*

Line Change Procedure

Applies to NF only

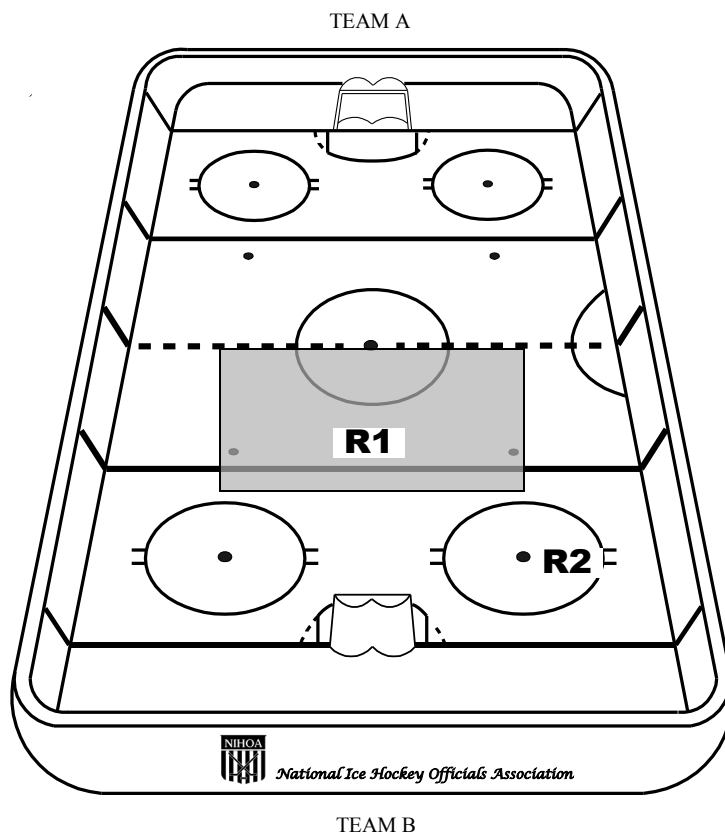

The non-puck retrieving R (R1) should be positioned in the area indicated above, allowing for a good field of vision of players.

R1 will jester (signal) towards the visiting team's bench to start their line change. After 5 seconds R1 will raise the non-whistle arm indicating to the visiting team their time to change players has ended and indicating to the home team it has 5 seconds remaining in which to complete its line change.

R1 will lower the raised arm. R2, conducting the face-off, will give a short toot of the whistle indicating to the teams the puck will be dropped within 5 seconds.

**Note: Rs are numbered for identification only.*